



Technical Data

20 Amp 20 AX Switches

Brief product description:

A range of IP rated accessories designed to protect the potentially dangerous electricity supply in the most arduous of conditions

Features:

- Clearly marked terminals with backed out captive screws for easy installation
- 20 Amp, 20AX inductive rated
- Covers to seal the fixing screws
- Earth terminal in mounting box
- All cable entries in the 4 sides have removable blanking caps.
- Housing will accept alternative switch modules from the Grid range
- Neon indicator that can be wired to illuminate when off or on depending on wiring blanking caps.

Product Images



WP12 / WP30



WP14



WP42

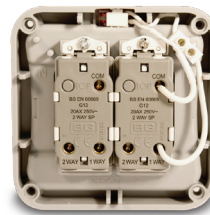

WP42 Rear View



WP12/30/42 Side View

Technical Specifications

Standard(s)	BS EN 60669-1
Rating	20 Amp 250V~ (20AX - no derating for inductive or fluorescent loads)
Switch Type	Single pole (WP12, WP14, WP42 products) Double pole (WP30 products)
Contact Gap	3.0mm minimum
Terminal Capacity	4 x 1.0mm ² 4 x 1.5mm ² 2 x 2.5mm ² 1 x 4.0mm ²
IP Rating	IP66
RoHS Directive	No
WEEE Directive	No
Number of 20mm cable entries	5 x 20mm. 1 in each of 3 sides and 2 in the remaining side 1 drill out entry 20/25mm in rear face
Size	91mm x 91mm x 67mm

20 Amp 20 AX Switches

Line Diagrams

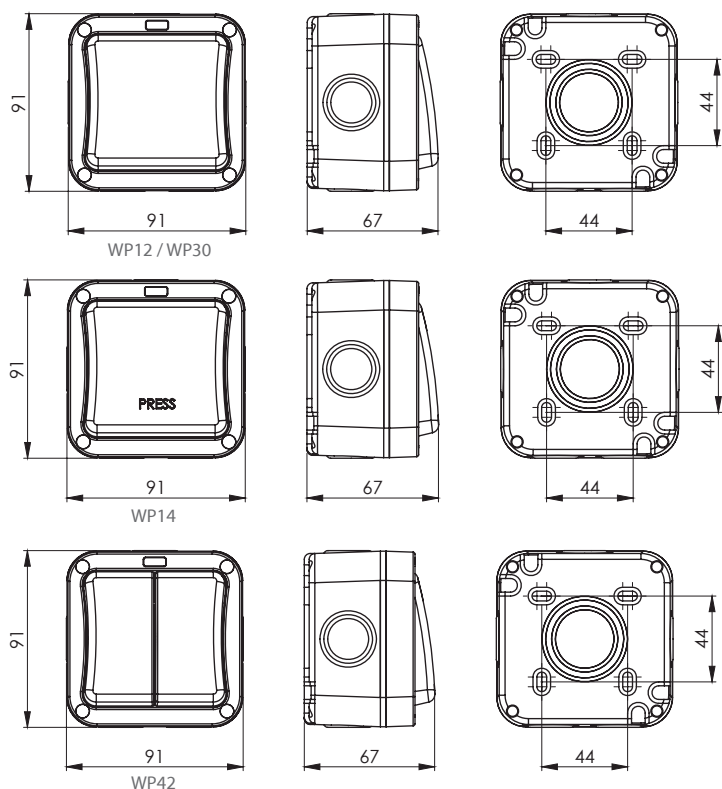

Packaging Information

Cat No.	Description	Packaging Type			Pack Quantity			Barcode		
		Product	Inner Box	Outer Box	Each	Inner Box	Outer Box	Individual	Inner Box	Outer Box
WP12	20A 1G, 2 Way	Printed Box	/	Printed Outer Box	1	/	10	5050765022132	/	5050765022231
WP42	20A 2G, 2 Way	Printed Box	/	Printed Outer Box	1	/	10	5050765022149	/	5050765022248
WP14	20A 1G, 1W, "PRESS"	Printed Box	/	Printed Outer Box	1	/	10	5050765022156	/	5050765022255
WP30	20A 1G, Double Pole	Printed Box	/	Printed Outer Box	1	/	10	5050765022163	/	5050765022262

Weights & Dimensions

Cat No.	Description	Dimension (W x L x H) cm			Weight (g)			CMB (m ³)
		Product	Inner Box	Outer Box	Each	Inner Box	Outer Box	Outer Box
WP12	20A 1G, 2 Way	10 x 7.5 x 10	/	40 x 22 x 12	170	/	210	0.01056
WP42	20A 2G, 2 Way	10 x 7.5 x 10	/	40 x 22 x 12	200	/	250	0.01056
WP14	20A 1G, 1W, "PRESS"	10 x 7.5 x 10	/	40 x 22 x 12	170	/	210	0.01056
WP30	20A 1G, Double Pole	10 x 7.5 x 10	/	40 x 22 x 12	180	/	210	0.01056

20 Amp 20 AX Switches

Installation Information

Safety Warning

Before use please read carefully and use in accordance with these safety wiring instructions.

Before commencing any electrical work ensure the supply **is switched off at the mains**. Either by switching off the consumer unit or by removing the appropriate fuse.

Wiring should be in accordance with the latest edition of the IEE regulations (BS 7671).

Wire Identification – Twin & Earth Cable

EARTH = Green/Yellow Slewing

NEUTRAL = Black (pre Apr 04) / Blue (after Apr 04)

LIVE = Red (pre Apr 04) / Brown (after Apr 04)



Technical Helpline: 0845 194 7584
If in doubt consult a competent electrician.

The ends of the individual conductors should have the insulation removed by approx. 12mm. Any bare earth conductors should be sleeved to within 12mm of the ends. (These details are for general information only and conductor lengths may need to be trimmed in certain installations).

Product Application & Features

The Weatherproof Switch range comprises a robust polycarbonate enclosure incorporating a 1 or 2 gang Grid Switch Module arrangement. It provides a convenient & safe wall-mounted control for outdoor equipment such as lighting, garden pond pumps, etc up to 20A current rating. Modules can be changed for others from the Grid range such as a 20A Double Pole or retractive 'PRESS' switch.

The enclosure is IP66 rated in use, which means that the sealed construction provides a very high level of protection against the ingress of both water & dust.

The Neon indicator can be used to illuminate the switch in a number of ways depending on wiring, & presence of supply Neutral.

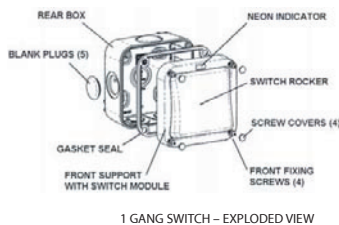

1 GANG SWITCH - EXPLODED VIEW

The Front Assembly comprises the Front Support, Switch Module(s) & Switch Rocker(s) which is mounted to the Rear Box using 4 captive fixing screws.

A Gasket Seal is located on the front edge of Rear Box. Re-usable Blank Plugs are pre-fitted & are pushed out from the inside. Screw Covers are provided to hide fixings after installation.



1 GANG SWITCH

2 GANG SWITCH

The 1 gang Switch has one Switch Module & one wide Rocker, the 2 gang has two Switch Modules & two half-width Rockers. The internal arrangement is identical except 1 gang has a Blank Plate fitted in place of one Switch Module as shown below.

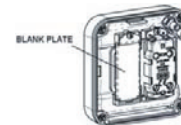

Safety Instructions – Important

Please Read 'Changes To Building Regulations'

1. An outdoor location should be chosen ensuring adequate access to a mains supply circuit. The circuit **MUST** be protected by an appropriate fuse, circuit breaker or RCD (Residual Current Device) in accordance with current IEE wiring regulations.
 2. Where conduit is used for cable runs, water condensation **MUST** be prevented from collecting inside the unit & conduit. Drain holes **MUST** be drilled out (see Installation Instructions)
 3. If metal conduit is used, earth continuity across the conduit must be maintained using appropriate connections (not supplied). An earth terminal in the Rear Box is provided as required.
 4. Where outdoor cable runs occur, ensure cable recommended for outdoor installations is used. In general, rubber insulated cable & plastic M20 cable glands can be used. Alternatively standard flat PVC twin & earth mains cable inside 20mm plastic or metal conduit may be used. Where necessary, SWA (Steel Wire Armoured) cable with metal cable glands should be used.
- The outdoor use of unprotected flat PVC insulated cable is **NOT** recommended.
5. To ensure continued safe & proper weatherproof operation, unused cable entries **MUST** have Blank Plugs fitted.

Installation Instructions

Ensure Safety Instructions Have Been Read First

The Rear Box has multiple cable entry positions on sides & one rear knockout cable entry. One side has 2 cable entry positions. Four drain hole positions are provided in relation to conduit positions as shown. Note position of earth terminal.

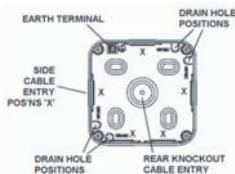

1. The unit should be mounted on a clean, rigid vertical surface suitable to accept screw type fixings. Surface should be reasonably flat as unevenness could cause product damage or affect operation.
2. Undo fixing screws & remove Front Assembly from Rear Box.

3. For cable entry, decide if conduit is being used & entry positions. For side, top or rear entry the lowermost drain hole position **MUST** be drilled out using a 5mm drill. **ONLY ONE** drain hole position must be drilled.

For bottom entry a drain hole **MUST NOT** be drilled in Rear Box, but a drain hole **MUST** be drilled at lowermost point of conduit run.

For rear entry, remove rear knock-out. For extra sealing protection, a channel around knock-out is provided to accept a bead of sealant (not supplied) when fixing to mounting surface.

NOTE

The drilling out of a drain hole or removing rear knock-out will reduce the IP rating of the product.

4. Mount the Rear Box using No.8 screws in all four, or at least two diagonal positions on fixing centres shown. The fixing holes are slotted to enable some rotation adjustment if required. Fit supplied Bunges over all used fixing screw positions to seal aperture recesses.

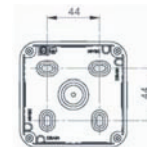

5. Make cable entry into Rear Box as required. Only remove Blank Plugs for positions used. Ensure adequate excess lengths of cable for connection to socket. Install & seal all cable glands & conduit to manufacturer's instructions. Ensure the Gasket Seal is properly fitted over front edge of Rear Box.
6. Offer up Front Assembly to Rear Box to determine final lengths of cables & cut to suit. Strip outer insulation as required & then trim insulation on individual wires 8-10mm to expose conductor ends.
7. Each standard Switch Module is a 2-way, single pole type & has 3 clearly marked terminals: - COM, 2 WAY & 1 WAY as shown.

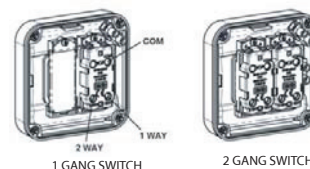

1 GANG SWITCH

2 GANG SWITCH

- 7a) For ONE WAY Switching, wire the module as follows:-
Connect **LIVE** wire to **COM** terminal
Connect **SWITCHED LIVE** wire to **1 WAY** terminal

20 Amp 20 AX Switches

Installation Information

7b) For **TWO WAY** Switching using this Switch & another remote switch, wire the module as follows:-

On one switch:-

Connect LIVE wire to COM terminal

Connect SWITCHED LIVE wire to 1 WAY/L1 terminal

On remote switch, using 3-core cable between switches

Connect wire core 1 between COM terminals

Connect wire core 2 between 1 WAY/L1 terminals

Connect wire core 3 between 2 WAY/L2 terminals

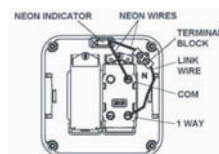

Note - the colours of the wires will be dependent on the type of cable used. See **Wire Identification** section for reference.

If a supplied Module has been changed for another compatible Switch Module type from the Grid range, the appropriate wiring instructions for the changed Module must be followed.

8. The unit has Neon Indicator pre-wired between the COM terminal & terminal block, with a Link wire to 1 WAY terminal. The Neon can be wired in one of three ways depending on presence of Neutral supply.

1. Power Mode: Neon ALWAYS ON when POWER is ON.

2. Switch Mode: Neon ONLY ON when switch is ON.

3. Locator Mode: Neon ONLY ON when switch is OFF.

All other connections should be as section 7.

Note – 2 Gang switch ONLY

For Locator & Switch Modes the Neon can ONLY be wired to work with one switch, it CAN NOT function with both switches.

9. Ensure all terminal screws are tight & all wires are neatly routed & not unduly stretched or pinched.

10. Any earth connections MUST be made & continuity maintained.

11. Where any earth conductor is a bare wire, it MUST be sleeved with green/Yellow sleeving.

12. After wiring Switch, refit Front Support onto Rear Box using fixing screws – DO NOT OVERTIGHTEN. Ensure the Gasket Seal is properly fitted over front edge of Rear Box before tightening screws.

13. Fit Screw Covers to complete installation.

14. Switch power back on & check Switch is working. The product is now ready to use.

15. During life of product, any cleaning should only be carried out with a damp cloth using a mild solution of detergent & warm water. DO NOT USE solvent based cleaners as these may cause damage.

Changes To Building Regulations – Important!

As from 1 January 2005, any electrical work done in domestic, fixed wiring installations in England and Wales, will have to follow new rules & changes to the Building Regulations Part P. These rules have been introduced to help reduce the number of deaths, injuries and fires caused by faulty installations.

The installation work may be carried out by anyone providing it is in accordance with the Regulation standards.

Certain electrical work (non-notifiable or minor work) may be carried out without having to use a registered electrician or notify Local Authority Building Control, such as:-

- replacing any electrical fitting (for example, socket outlets, light fittings, control switches)
- adding fused spurs, sockets or lights to an existing circuit (but not in a kitchen, bathroom or outdoors)
- any repair or maintenance work

For minor work done by a non-qualified electrician, it is highly recommended it is checked by a qualified electrician to ensure it is safe.

For all other work (notifiable or major work) a Building Regulations application is required & it must be checked to make sure it is safe.

This may be done by either an electrician who is part of a competent person self-certification scheme, or by notifying the Local Authority Building Control Department who will make required arrangements.

An application must be made to the Local Authority before commencing work such as:-

- adding a new circuit
- adding/altering any circuit in a room with water (kitchen, bathroom, etc)
- adding/altering any circuit outdoors (outdoor sockets, lights, etc)

Where work is done by a qualified electrician, they will be responsible for checking the work, & Local Authority does not need notification.

Where a qualified electrician or Local Authority is responsible for checking the work, they will provide a certificate or notice to confirm that the installation is tested & safe to use.

IT IS RECOMMENDED TO USE A QUALIFIED ELECTRICIAN

If there is any doubt whether electrical work needs notification of the Local Authority, they should be contacted first for advice.